



**Instruction Manual**

# ***FRENIC-AQUA***

## **⚠ CAUTION**

Thank you for purchasing our FRENIC-AQUA series of inverters.

- This product is designed to drive a three-phase induction motor. Read through this manual to become familiar with the handling procedure and correct use.
- Improper handling might result in incorrect operation, short life cycle, or failure of this product as well as the motor.
- Deliver this manual to the end user of this product. Keep this manual in a safe place until this product is discarded.
- For instructions on how to use an optional device, refer to the instruction and installation manuals for that optional device.

**Fuji Electric Co., Ltd.**

**INR-SI47-1611-E**

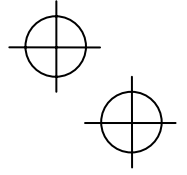
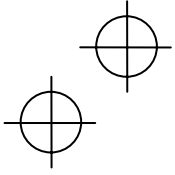

Copyright © 2011 Fuji Electric Co., Ltd.

All rights reserved.

No part of this publication may be reproduced or copied without prior written permission from Fuji Electric Co., Ltd.

All products and company names mentioned in this manual are trademarks or registered trademarks of their respective holders.

The information contained herein is subject to change without prior notice for improvement.

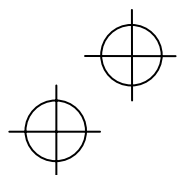
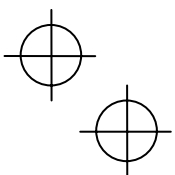

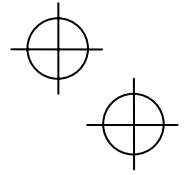
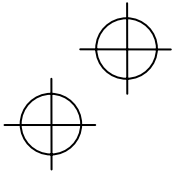

## Preface

Thank you for purchasing our FRENIC-AQUA series of inverters. This product is designed to drive a three-phase induction motor.

This instruction manual provides only minimum requisite information for wiring and operation of the product. Read through this manual before use.

### Related documentation

Listed below are the other materials related to the functions, specifications, wiring, configuration and maintenance of this product. Contact your nearest service representative for these materials.

- FRENIC-AQUA User's Manual

These materials are subject to change without notice. Be sure to obtain the latest editions for use.

### ■ Safety precautions

Read this manual thoroughly before proceeding with installation, connections (wiring), operation, or maintenance and inspection. Ensure you have sound knowledge of the device and familiarize yourself with all safety information and precautions before proceeding to operate the inverter.

Safety precautions are classified into the following two categories in this manual.

<b>WARNING</b>	Failure to heed the information indicated by this symbol may lead to dangerous conditions, possibly resulting in death or serious bodily injuries.
<b>CAUTION</b>	Failure to heed the information indicated by this symbol may lead to dangerous conditions, possibly resulting in minor or light bodily injuries and/or substantial property damage.

Failure to heed the information contained under the CAUTION title can also result in serious consequences. These safety precautions are of utmost importance and must be observed at all times.

### Application

<b>WARNING</b>
<ul style="list-style-type: none"><li>• This product is designed to drive a three-phase induction motor. Do not use it for single-phase motors or for other purposes. <b>Fire or an accident could occur.</b></li><li>• This product may not be used for a life-support system or other purposes directly related to the human safety.</li><li>• Though the product is manufactured under strict quality control, install safety devices for applications where serious accidents or property damages are foreseen in relation to the failure of it. <b>An accident could occur.</b></li></ul>

### Installation

<b>WARNING</b>
<ul style="list-style-type: none"><li>• Install the inverter on a base made of metal or other non-flammable material. <b>Otherwise, a fire could occur.</b></li><li>• Do not place flammable object nearby. <b>Doing so could cause fire.</b></li></ul>

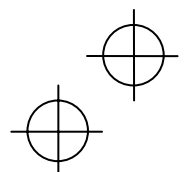
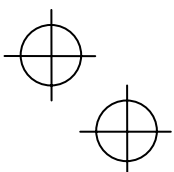



## ⚠ CAUTION

- Do not support the inverter by its front cover during transportation.  
**Doing so could cause a drop of the inverter and injuries.**
- Prevent lint, paper fibers, sawdust, dust, metallic chips, or other foreign materials from getting into the inverter or from accumulating on the heat sink.
- When changing the positions of the top and bottom mounting bases, use only the specified screws.  
**Otherwise, a fire or an accident might result.**
- Do not install or operate an inverter that is damaged or lacking parts.  
**Doing so could cause fire, an accident or injuries.**

### Wiring

## ⚠ WARNING ⚠

- If no zero-phase current (earth leakage current) detective device such as a ground-fault relay is installed in the upstream power supply line in order to avoid the entire power supply system's shutdown undesirable to factory operation, install a residual-current-operated protective device (RCD)/earth leakage circuit breaker (ELCB) individually to inverters to break the individual inverter power supply lines only.  
**Otherwise, a fire could occur.**
- When wiring the inverter to the power source, insert a recommended molded case circuit breaker (MCCB) or residual-current-operated protective device (RCD)/earth leakage circuit breaker (ELCB) (with overcurrent protection) in the path of each pair of power lines to inverters. Use the recommended devices within the recommended current capacity.
- Use wires in the specified size.
- Tighten terminals with specified torque.  
**Otherwise, a fire could occur.**
- When there is more than one combination of an inverter and motor, do not use a multicore cable for the purpose of handling their wirings together.
- Do not connect a surge killer to the inverter's output (secondary) circuit.  
**Doing so could cause a fire.**
- Ground the inverter in compliance with the national or local electric code.
- Be sure to ground the inverter's grounding terminals G.  
**Otherwise, an electric shock or a fire could occur.**
- Qualified electricians should carry out wiring.
- Be sure to perform wiring after turning the power OFF.  
**Otherwise, an electric shock could occur.**
- Be sure to perform wiring after installing the inverter unit.  
**Otherwise, an electric shock or injuries could occur.**
- Ensure that the number of input phases and the rated voltage of the product match the number of phases and the voltage of the AC power supply to which the product is to be connected.
- When using this product in combination with a PWM converter, refer to the instructions given in the User's Manual.  
**Otherwise, a fire or an accident could occur.**
- Do not connect the power supply wires to the inverter output terminals (U, V, and W).  
**Doing so could cause fire or an accident.**



## ⚠ WARNING

- In general, sheaths of the control signal wires are not specifically designed to withstand a high voltage (i.e., reinforced insulation is not applied). Therefore, if a control signal wire comes into direct contact with a live conductor of the main circuit, the insulation of the sheath might break down, which would expose the signal wire to a high voltage of the main circuit. Make sure that the control signal wires will not come into contact with live conductors of the main circuit.

**Doing so could cause an accident or an electric shock.**

## ⚠ WARNING ⚠

- Before changing the switches, **turn OFF the power and wait at least 10 minutes**. Further, make sure, using a multimeter or a similar instrument, that the DC link bus voltage between the terminals P(+) and N(-) has dropped to the safe level (+25 VDC or below).

**Otherwise, an electric shock could occur.**

## ⚠ CAUTION ⚠

- The inverter, motor and wiring generate electric noise. Be careful about malfunction of the nearby sensors and devices. To prevent them from malfunctioning, implement noise control measures.

**Otherwise an accident could occur.**



- The leakage current of the EMC filter built-in type of inverters is comparatively large. Be sure to perform protective grounding.

**Otherwise, an accident or an electric shock could occur.**

### Operation

## ⚠ WARNING ⚠

- Be sure to mount the front cover before turning the power ON. Do not remove the cover when the inverter power is ON.  
**Otherwise, an electric shock could occur.**
- Do not operate switches with wet hands.  
**Doing so could cause electric shock.**
- If the auto-reset function has been selected, the inverter may automatically restart and drive the motor depending on the cause of tripping. Design the machinery or equipment so that human safety is ensured at the time of restarting.  
**Otherwise, an accident could occur.**
- If the stall prevention function (current limiter), automatic deceleration (anti-regenerative control), or overload prevention control has been selected, the inverter may operate with acceleration/deceleration or frequency different from the commanded ones. Design the machine so that safety is ensured even in such cases.
- The  key on the keypad is effective only when the keypad operation is enabled with function code F02 (= 0, 2 or 3). When the keypad operation is disabled, prepare an emergency stop switch separately for safe operations.

Switching the run command source from keypad (local) to external equipment (remote) by turning ON the "Enable communications link" command **LE** disables the  key. To enable the  key for an emergency stop, select the STOP key priority with function code H96 (= 1 or 3).

- If any of the protective functions have been activated, first remove the cause. Then, after checking that the all run commands are set to OFF, release the alarm. If the alarm is released while any run commands are set to ON, the inverter may supply the power to the motor, running the motor.

**Otherwise, an accident could occur.**



## ⚠️ WARNING ⚠️

- If you enable the "Restart mode after momentary power failure" (Function code F14 = 3 to 5), then the inverter automatically restarts running the motor when the power is recovered.  
Design the machinery or equipment so that human safety is ensured after restarting.
- If the user configures the function codes wrongly without completely understanding this Instruction Manual and the FRENIC-AQUA User's Manual, the motor may rotate with a torque or at a speed not permitted for the machine.  
**An accident or injuries could occur.**
- Even if the inverter has interrupted power to the motor, if the voltage is applied to the main circuit input terminals L1/R, L2/S and L3/T, voltage may be output to inverter output terminals U, V, and W.
- Even if the motor is stopped due to DC braking, voltage is output to inverter output terminals U, V, and W.  
**An electric shock may occur.**
- The inverter can easily accept high-speed operation. When changing the speed setting, carefully check the specifications of motors or equipment beforehand.  
**Otherwise, injuries could occur.**

## ⚠️ CAUTION

- Do not touch the heat sink because it becomes very hot.  
**Doing so could cause burns.**
- The DC brake function of the inverter does not provide any holding mechanism.  
**Injuries could occur.**
- Ensure safety before modifying the function code settings.  
Run commands (e.g., "Run forward" **FWD**, "Force to run" **FMS**), stop commands (e.g., "Coast to a stop" **BX**), and frequency change commands can be assigned to digital input terminals. Depending upon the assignment states of those terminals, modifying the function code setting may cause a sudden motor start or an abrupt change in speed.
- When the inverter is controlled with the digital input signals, switching run or frequency command sources with the related terminal commands (e.g., **SS1**, **SS2**, **SS4**, **SS8**, **Hz2/Hz1**, **Hz/PID**, **IVS**, **LE** and **FMS**) may cause a sudden motor start or an abrupt change in speed.
- Ensure safety before modifying customizable logic related function code settings (U codes and related function codes) or turning ON the "Cancel customizable logic" terminal command **CLC**. Depending upon the settings, such modification or cancellation of the customizable logic may change the operation sequence to cause a sudden motor start or an unexpected motor operation.
- If any abnormality is found in the inverter or motor, immediately stop it and perform troubleshooting, referring to the User's Manual.  
**An accident or injuries could occur.**



## Maintenance and inspection, and parts replacement

### **WARNING**

- Before proceeding to maintenance or inspection, **turn OFF the power and wait at least 10 minutes.** Further, make sure, using a multimeter or a similar instrument, that the DC link bus voltage between the terminals P(+) and N(-) has dropped to the safe level (+25 VDC or below).  
**Otherwise, an electric shock could occur.**
- Maintenance, inspection, and parts replacement should be made only by qualified persons.
- Take off the watch, rings and other metallic objects before starting work.
- Use insulated tools.  
**Otherwise, an electric shock or injuries could occur.**
- Never modify the inverter.  
**Doing so could cause an electric shock or injuries.**

## Disposal

### **CAUTION**

- Treat the inverter as an industrial waste when disposing of it.  
**Otherwise injuries could occur.**

### **GENERAL PRECAUTIONS**

Drawings in this manual may be illustrated without covers or safety shields for explanation of detail parts. Restore the covers and shields in the original state and observe the description in the manual before starting operation.

## Icons

The following icons are used throughout this manual.

 **Note** This icon indicates information which, if not heeded, can result in the inverter not operating to full efficiency, as well as information concerning incorrect operations and settings which can result in accidents.

 **Tip** This icon indicates information that can prove handy when performing certain settings or operations.

 This icon indicates a reference to more detailed information.

## Conformity to the Low Voltage Directive in the EU

If installed according to the guidelines given below, inverters marked with CE are considered as compliant with the Low Voltage Directive 2006/95/EC.

## Compliance with European Standards

Adjustable speed electrical power drive systems (PDS).

Part 5-1: Safety requirements. Electrical, thermal and energy. EN61800-5-1: 2007

# ⚠ WARNING ⚠

- The ground terminal  G should always be connected to the ground. Do not use only a residual-current-operated protective device (RCD)/earth leakage circuit breaker (ELCB)\* as the sole method of electric shock protection. Be sure to use ground wires of recommended size listed on page vii.  
\*With overcurrent protection.
- To prevent the risk of hazardous accidents that could be caused by damage of the inverter, install the specified fuses in the supply side (primary side) according to the following tables.
  - Breaking capacity: Min. 10 kA
  - Rated voltage: Min. 500 V

Power supply voltage	Nominal applied motor (kW)	Inverter type	Fuse rating (A)
Three-phase 400 V	0.75	FRN0.75AQ1 ■-4□	3 (IEC60269-1)
	1.5	FRN1.5AQ1 ■-4□	6 (IEC60269-1)
	2.2	FRN2.2AQ1 ■-4□	10 (IEC60269-1)
	3.7 (4.0)*	FRN3.7AQ1 ■-4□ FRN4.0AQ1 ■-4E	15 (IEC60269-1)
	5.5	FRN5.5AQ1 ■-4□	20 (IEC60269-1)
	7.5	FRN7.5AQ1 ■-4□	25 (IEC60269-1)
	11	FRN11AQ1 ■-4□	35 (IEC60269-1)
	15	FRN15AQ1 ■-4□	50 (IEC60269-1)
	18.5	FRN18.5AQ1 ■-4□	60 (IEC60269-1)
	22	FRN22AQ1 ■-4□	70 (IEC60269-1)
	30	FRN30AQ1 ■-4□	100 (IEC60269-1)
	37	FRN37AQ1 ■-4□	125 (IEC60269-1)

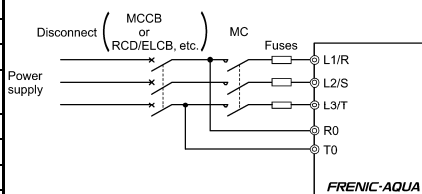

\* 4.0 kW for the EU. The inverter type is FRN4.0AQ1 ■-4E.

**Note:** A box (■) replaces an alphabetic letter depending on the enclosure.

A box (□) replaces an alphabetic letter depending on the shipping destination.

- When used with the inverter, a molded case circuit breaker (MCCB), residual-current-operated protective device (RCD)/earth leakage circuit breaker (ELCB) or magnetic contactor (MC) should conform to the EN or IEC standards.
- When you use a residual-current-operated protective device (RCD)/earth leakage circuit breaker (ELCB) for protection from electric shock in direct or indirect contact power lines or nodes, be sure to install **type B of RCD/ELCB** on the input (primary) of the inverter.
- The IP20 or IP00 rated inverter should be used in an environment that does not exceed Pollution Degree 2 requirements. If the environment conforms to Pollution Degree 3 or 4, install the inverter in an enclosure of IP54 or higher.
- Install the inverter, AC reactor (ACR), input or output filter in an enclosure with minimum degree of protection of IP2X (Top surface of enclosure shall be minimum IP4X when it can be easily accessed), to prevent human body from touching directly to live parts of these equipment.
- Do not connect any copper wire directly to grounding terminals. Use crimp terminals with tin or equivalent plating to connect them.
- When you use an inverter at an altitude of more than 2000 m, you should apply basic insulation for the control circuits of the inverter. The inverter cannot be used at altitudes of more than 3000 m.



Conformity to the Low Voltage Directive in the EU (Continued)

**⚠ WARNING ⚠**

9. Use wires listed in EN60204 Appendix C.

Power supply voltage	Nominal applied motor	Inverter type	MCCB or RCD/ELCB *1 Rated current	Recommended wire size (mm <sup>2</sup> )					
				Main terminal		Control circuit	Aux. control power supply [R0, T0]		
				Main power input				Inverter outputs [U, V, W] *2	
				[L1/R, L2/S, L3/T] *2	Inverter's grounding [G]				
Three-phase 400 V	0.75	FRN0.75AQ1■-4□	5	2.5	10	2.5	0.75	2.5	
	1.5	FRN1.5AQ1■-4□							
	2.2	FRN2.2AQ1■-4□							
	3.7 (4.0)*	FRN3.7AQ1■-4□ FRN4.0AQ1■-4E	10						
	5.5	FRN5.5AQ1■-4□							
	7.5	FRN7.5AQ1■-4□	20						
	11	FRN11AQ1■-4□	30						4
	15	FRN15AQ1■-4□	40						6
	18.5	FRN18.5AQ1■-4□	50						10
	22	FRN22AQ1■-4□							
	30	FRN30AQ1■-4□							16
	37	FRN37AQ1■-4□	100						25

\* 4.0 kW for the EU. The inverter type is FRN4.0AQ1■-4E.

**Note:** A box (■) replaces an alphabetic letter depending on the enclosure.  
A box (□) replaces an alphabetic letter depending on the shipping destination.

\*1 The frame size and model of the MCCB or RCD/ELCB (with overcurrent protection) will vary, depending on the power transformer capacity. Refer to the User's Manual for details.

\*2 The recommended wire size for main circuits is for the 70°C 600 V PVC wires used at a surrounding temperature of 40°C.

10. The inverter has been tested with IEC61800-5-1 2007 short-circuit test under the following conditions.  
Short-circuit current in the supply: 10,000 A  
Maximum 480 V

### Conformity with UL standards and CSA standards (cUL-listed for Canada)

UL/cUL-listed inverters are subject to the regulations set forth by the UL standards and CSA standards (cUL-listed for Canada) by installation within precautions listed below.

## ⚠ CAUTION

1. Solid state motor overload protection (motor protection by electronic thermal overload relay) is provided in each model.  
Use function codes F10 to F12 to set the protection level.
2. Use Cu wire only.
3. Use Class 1 wire only for control circuits.
4. Short circuit rating  
"Suitable For Use On A Circuit Of Delivering Not More Than 100,000 rms Symmetrical Amperes, 480 Volts Maximum when protected by Class J Fuses or a Circuit Breaker having an interrupting rating not less than 100,000 rms Symmetrical Amperes, 480 Volts Maximum."  
"Integral solid state short circuit protection does not provide branch circuit protection. Branch circuit protection must be provided in accordance with the National Electrical Code and any additional local codes."
5. Field wiring connections must be made by a UL Listed and CSA Certified closed-loop terminal connector sized for the wire gauge involved. Connector must be fixed using the crimp tool specified by the connector manufacturer.
6. All circuits with terminals L1/R, L2/S, L3/T, R0, T0 must have a common disconnect and be connected to the same pole of the disconnect if the terminals are connected to the power supply.

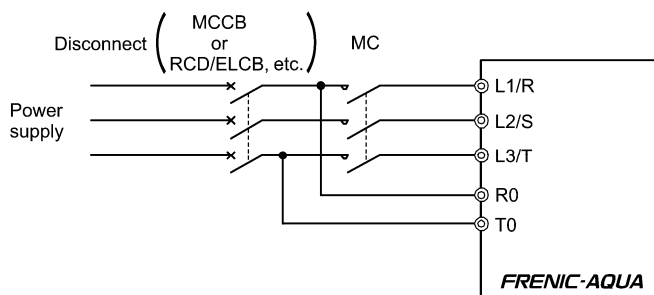

Conformity with UL standards and CSA standards (cUL-listed for Canada) (continued)

**⚠ CAUTION**

7. Install UL certified fuses or circuit breaker between the power supply and the inverter, referring to the table below.

Power supply voltage	Nominal applied motor	Inverter type	Class J fuse size	Circuit breaker trip size	Required torque lb-in (N•m)		
					Main terminal	Control circuit	Aux. control power supply
Three-phase 400V	0.75	FRN0.75 AQ1 ■-4□	3	5	15.9 (1.8)	6.1 (0.7)	10.6 (1.2)
	1.5	FRN1.5AQ1 ■-4□	6				
	2.2	FRN2.2AQ1 ■-4□	10				
	3.7 (4.0)*	FRN3.7AQ1 ■-4□ FRN4.0AQ1 ■-4E	15	10			
	5.5	FRN5.5AQ1 ■-4□	20				
	7.5	FRN7.5AQ1 ■-4□	25	20			
	11	FRN11AQ1 ■-4□	35	30			
	15	FRN15AQ1 ■-4□	50	40			
	18.5	FRN18.5AQ1 ■-4□	60	50			
	22	FRN22AQ1 ■-4□	70				
	30	FRN30AQ1 ■-4□	100	75			
37	FRN37AQ1 ■-4□	125	100				

\* 4.0 kW for the EU. The inverter type is FRN4.0AQ1 ■-4E.

**Note:** A box (■) replaces an alphabetic letter depending on the enclosure.  
A box (□) replaces an alphabetic letter depending on the shipping destination.

Conformity with UL standards and CSA standards (cUL-listed for Canada) (continued)

**⚠ CAUTION**

Power supply voltage	Nominal applied motor	Inverter type	Wire size AWG (mm <sup>2</sup> )		Control circuit	Aux. control power supply		
			Main terminal					
			L1/R, L2/S, L3/T *1	U, V, W *1				
			75°C Cu wire	75°C Cu wire				
Three-phase 400V	0.75	FRN0.75AQ1■-4□	14 (2.1)	14 (2.1)	18 (0.8)	14 (2.1) *1		
	1.5	FRN1.5AQ1■-4□						
	2.2	FRN2.2AQ1■-4□						
	3.7	FRN3.7AQ1■-4□						
	(4.0) *	FRN4.0AQ1■-4E						
	5.5	FRN5.5AQ1■-4□						
	7.5	FRN7.5AQ1■-4□					12 (3.3)	
	11	FRN11AQ1■-4□					12 (3.3)	10 (5.3)
	15	FRN15AQ1■-4□					10 (5.3)	8 (8.4)
	18.5	FRN18.5AQ1■-4□					8 (8.4)	
	22	FRN22AQ1■-4□					8 (8.4)	
30	FRN30AQ1■-4□	6 (13.3)	6 (13.3)					
37	FRN37AQ1■-4□	4 (21.2)	2 (33.6)					

\* 4.0 kW for the EU. The inverter type is FRN4.0AQ1■-4E.

**Note:** A box (■) replaces an alphabetic letter depending on the enclosure.

A box (□) replaces an alphabetic letter depending on the shipping destination.

\*1 No terminal end treatment is required for connection.

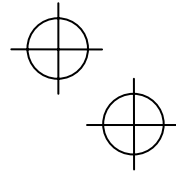
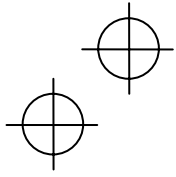

## Table of Contents

Preface .....	i
■ Safety precautions .....	i
Chapter 1 BEFORE USE .....	1-1
1.1 Acceptance Inspection and Appearance of Product .....	1-1
Chapter 2 MOUNTING AND WIRING THE INVERTER...2-1	
2.1 Installing the Inverter .....	2-1
2.2 Wiring .....	2-2
2.2.1 Removing and mounting the front cover and the wiring plate.....	2-2
2.2.2 Recommended wire sizes.....	2-3
2.2.3 Terminal arrangement diagrams and screw specifications .....	2-3
2.2.4 Terminal functions and wiring order .....	2-5
2.2.5 Connection diagrams.....	2-7
2.2.6 Setting up the slide switches.....	2-10
Chapter 3 NAMES AND FUNCTIONS OF KEYPAD COMPONENTS .....	3-1
Chapter 4 RUNNING THE MOTOR FOR A TEST .....	4-1
4.1 Checking Prior to Powering ON.....	4-1
4.2 Powering ON and Checking .....	4-1
4.3 Configuring the Function Code Data Before Test Run .....	4-2
4.4 Running the Inverter for Motor Operation Check....	4-2
4.5 Preparation for Practical Operation .....	4-2
Chapter 5 TROUBLESHOOTING .....	5-1
5.1 Alarm Codes.....	5-1
Chapter 6 MAINTENANCE AND INSPECTION .....	6-1
6.1 Daily Inspection .....	6-1
6.2 Periodic Inspection .....	6-1
6.3 List of Periodic Replacement Parts .....	6-3
6.4 Inquiries about Product and Guarantee.....	6-3
6.4.1 When making an inquiry .....	6-3
6.4.2 Product warranty.....	6-3
Chapter 7 SPECIFICATIONS .....	7-1
7.1 Standard Model .....	7-1
7.2 External Dimensions .....	7-2
Chapter 8 CONFORMITY WITH STANDARDS .....	8-1
8.1 Compliance with European Standards .....	8-1
8.2 Conformity to the Lower Voltage Directive in the EU.....	8-1
8.3 Compliance with EMC Standards .....	8-1
8.3.1 General .....	8-1
8.3.2 Recommended installation procedure .....	8-1
8.3.3 Leakage current of the EMC filter .....	8-2
8.4 Harmonic Component Regulation in the EU.....	8-3
8.4.1 General comments .....	8-3
8.4.2 Compliance with EN61000-3-2.....	8-3
8.4.3 Compliance with EN61000-3-12 .....	8-3
8.5 Compliance with UL Standards and Canadian Standards (cUL certification).....	8-3
8.5.1 General comments .....	8-3
8.5.2 Considerations when using FRENIC-AQUA in systems to be certified by UL and cUL.....	8-3

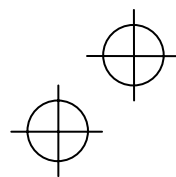
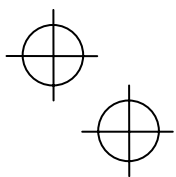

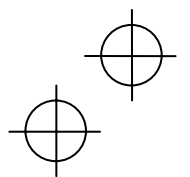
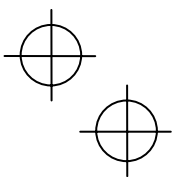
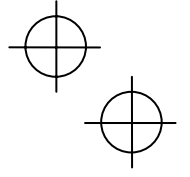
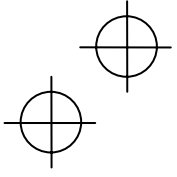

## Chapter 1 BEFORE USE

### 1.1 Acceptance Inspection and Appearance of Product

Unpack the package and check the following:

- (1) An inverter and instruction manual (this book) are contained in the package.
- (2) The inverter has not been damaged during transportation—there should be no dents or parts missing.
- (3) The inverter is the type you ordered. You can check the type and specifications on the main nameplate. (A total of four nameplates and warning plates are attached to the inverter as shown below.)

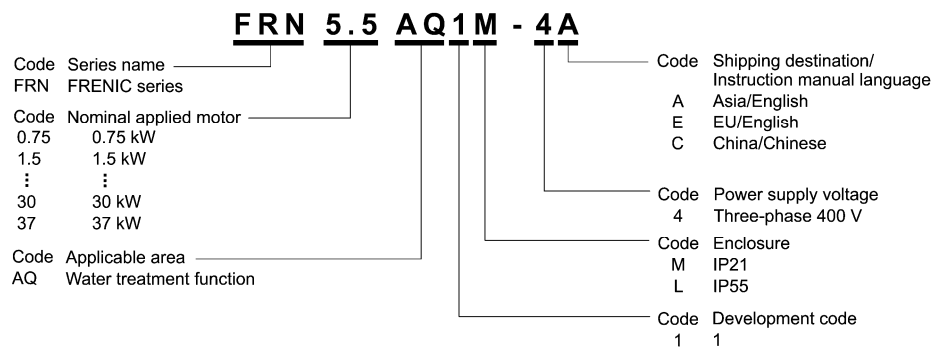
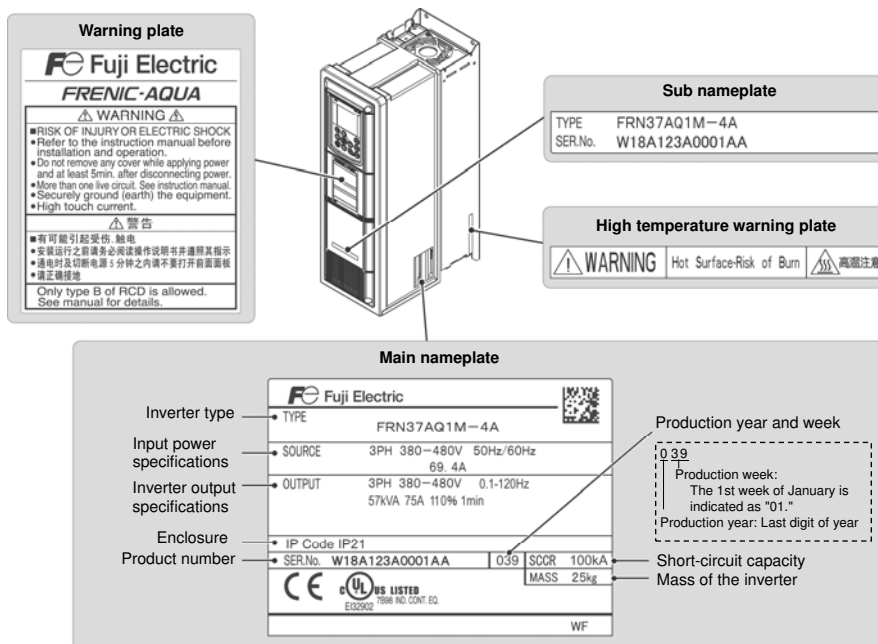

**Note** In this manual, inverter types are denoted as "FRN\_ \_AQ1■-4□." The boxes ■ and □ replace alphabetic letters depending on the enclosure and shipping destination, respectively.

If you suspect the product is not working properly or if you have any questions about your product, contact your Fuji Electric representative.

## Chapter 2 MOUNTING AND WIRING THE INVERTER

### 2.1 Installing the Inverter

#### (1) Mounting base

Install the inverter on a base made of metal or other non-flammable material. Do not mount the inverter upside down or horizontally.

#### (2) Clearances

Ensure that the minimum clearances indicated in Figure 2.1 and Table 2.1 are maintained at all times. When installing the inverter in the panel of your system, take extra care with ventilation inside the panel as the surrounding temperature easily rises. Do not install the inverter in a small panel with poor ventilation.

#### ■ When mounting two or more inverters

When mounting two or more inverters in the same unit or panel, basically lay them out side by side. When mounting them necessarily one above the other, be sure to separate them with a partition plate or the like so that any heat radiating from an inverter will not affect the one(s) above.

Table 2.1 Clearances (mm)

Inverter capacity	A	B	C
0.75 to 37 kW	10	100	100

C: Space required in front of the inverter unit



Figure 2.1 Mounting Direction and Required Clearances



## 2.2 Wiring

Before wiring, remove the front cover and wiring plate and then set cable glands or conduits on the wiring plate. After wiring, mount the wiring plate and front cover back into place. (The cable glands or conduits should be prepared by the customer.)

### 2.2.1 Removing and mounting the front cover and the wiring plate

#### (1) Removing the front cover and the wiring plate

- ① Loosen the (four or six) screws on the front cover, hold the right and left ends of the front cover, and remove it towards you.
- ② Loosen the four screws on the wiring plate, hold the right and left ends of the wiring plate, and remove it downwards.

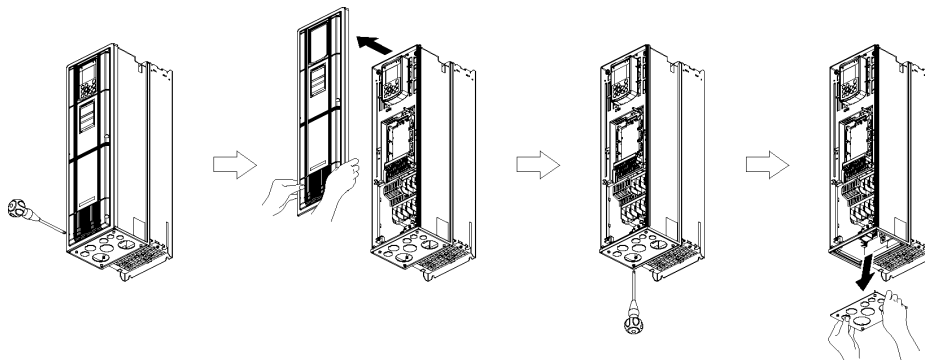

Figure 2.2 Removing the Front Cover and the Wiring Plate (FRN37AQ1M-4□)

**Tip** - The wiring plate can be removed even with the front cover being mounted.  
- To expose the control printed circuit board (control PCB), remove the front cover.

#### (2) Punching out semi-perforated sections in the wiring plate and setting cable glands or conduits

- ① Lightly tap the semi-perforated sections from the inside of the wiring plate using the hand grip of a screwdriver or the like to punch them out.
- ② Set the cable glands or conduits on the wiring plate and then carry out wiring.

**Note** Take care not to get injured by the edge of the parts.

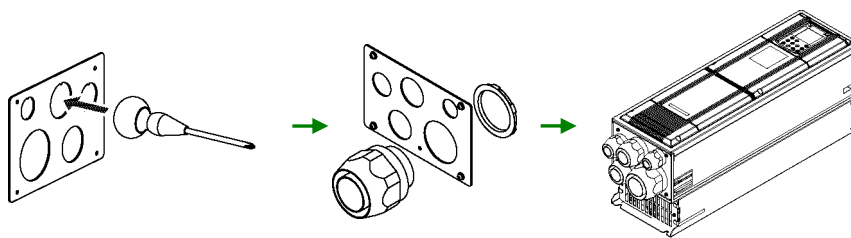

Figure 2.3 Punching Out Semi-perforated Sections in the Wiring Plate and Setting Cable Glands or Conduits

#### (3) Mounting the wiring plate and the front cover

After wiring, mount the wiring plate and front cover back into place. (Tightening torque: 1.8 N·m (M4))

### 2.2.2 Recommended wire sizes

For the recommended wire sizes for the main circuits, refer to the "Conformity to the Low Voltage Directive in the EU" and "Conformity with UL standards and CSA standards (cUL-listed for Canada)" given in Preface.

### 2.2.3 Terminal arrangement diagrams and screw specifications

The tables and figures given below show the screw specifications and terminal arrangement diagrams. Note that the terminal arrangements differ depending on the inverter capacity.

**Note** Do not make wiring to empty main circuit terminals marked with (NC) in the figures given below. Doing so may break the inverter.

#### (1) Main circuit terminals

Table 2.2 Main Circuit Terminals

Power supply voltage	Nominal applied motor (kW)	Inverter type	Refer to:	Main circuit terminals		Grounding terminals		Aux. control power supply	
				Screw size	Tightening torque (N·m)	Screw size	Tightening torque (N·m)	Screw size	Tightening torque (N·m)
Three-phase 400V	0.75	FRN0.75AQ1■-4□	Figure A	M4	15.9 (1.8)	M4	15.9 (1.8)	M3.5	10.6 (1.2)
	1.5	FRN1.5AQ1■-4□							
	2.2	FRN2.2AQ1■-4□							
	3.7 (4.0)*	FRN3.7AQ1■-4□ FRN4.0AQ1■-4E							
	5.5	FRN5.5AQ1■-4□							
	7.5	FRN7.5AQ1■-4□	Figure B	M6	51.3 (5.8)	M6	51.3 (5.8)		
	11	FRN11AQ1■-4□							
	15	FRN15AQ1■-4□							
	18.5	FRN18.5AQ1■-4□							
	22	FRN22AQ1■-4□							
30	FRN30AQ1■-4□	Figure C	M6	51.3 (5.8)	M6	51.3 (5.8)			
37	FRN37AQ1■-4□								

\* 4.0 kW for the EU. The inverter type is FRN4.0AQ1■-4E.

**Note:** A box (■) replaces an alphabetic letter depending on the enclosure.  
A box (□) replaces an alphabetic letter depending on the shipping destination.

Figure A

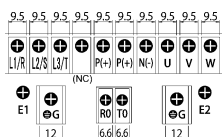

Figure B

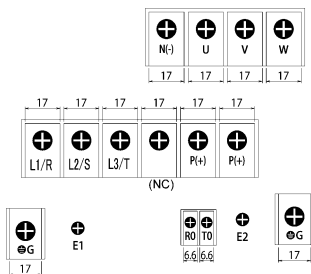
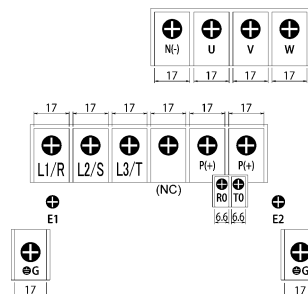

Figure C



(NC): No connection

(2) Arrangement of control circuit terminals

■ Screw type of terminal block  
(common to all inverter types)

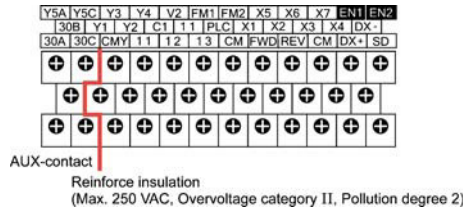

■ Europe type of terminal block  
(common to all inverter types)

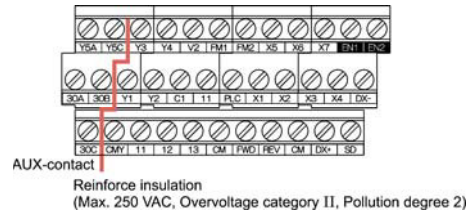
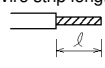

Table 2.3 Control Circuit Terminals

Terminal block type	Screw specifications		Recommended wire size (mm <sup>2</sup> )	Type of screwdriver (tip shape)	Wire strip length 	Gauge No. of wire insertion slot
	Screw size	Tightening torque				
Screw type	M3	0.7 N·m	0.75 mm <sup>2</sup>	-	-	-
Europe type		0.5 to 0.6 N·m		Flat screwdriver (0.6 mm x 3.5 mm)	6 mm	A1*





\*In conformity with the IEC60947-7-1

## 2.2.4 Terminal functions and wiring order

### Main circuit terminals and grounding terminals

The table below shows the order of wiring and terminal functions. Carry out wiring in the order shown below.

Table 2.4 Order of Wiring and Functions of Main Circuit Terminals

Classification	Order of wiring	Name	Symbol	Functions
Main circuit (Note)	①	Primary grounding terminals for inverter enclosure		Two grounding terminals (  G) are not exclusive to the power supply wiring (primary circuit) or motor wiring (secondary circuit). Be sure to ground either of the two grounding terminals for safety and noise reduction.
	②	Secondary grounding terminals for motor Inverter output terminals	 U, V, W	Connect the secondary grounding wire to the grounding terminal (  G). Connect the three wires of the 3-phase motor to terminals U, V, and W, aligning the phases each other. (*1)
	③	DC link bus terminals	P(+), N(-)	A DC link bus is connectable to these terminals. When you need to use the DC link bus terminals P(+) and N(-), consult your Fuji Electric representative.
	④	Main circuit power input terminals	L1/R, L2/S, L3/T	The three-phase input power lines are connected to these terminals. (*2) If the power wires are connected to other terminals, the inverter will be damaged when the power is turned ON.
	⑤	Auxiliary control power input terminals	R0, T0	Connect the same AC power as for the main circuit to these terminals as a control circuit power backup.
Control circuit	⑥	Control circuit terminals	See Table 2.5.	Route the wiring of the control circuit as far from that of the main circuit as possible. Otherwise, electric noise may cause malfunctions. When the Enable function is not to be used, short-circuit terminals [EN1] and [PLC] and terminals [EN2] and [PLC] using jumper wires.

(Note) Do not make wiring to empty main circuit terminals (NC). For details about the terminal block, refer to Section 2.2.3 "Terminal arrangement diagrams and screw specifications."

To make the machinery or equipment compliant with the EMC standards, wire the motor and inverter in accordance with the following.

(\*1) Use shielded wires for the motor cable and route the cable as short as possible. Firmly clamp the shield to the specified point inside the inverter.

(\*2) When wiring the main circuit power input lines of the inverters of 11 to 37 kW, be sure to pass them through a ferrite core.

 **Tip** When shielded wires are not used for the motor cable, remove the motor cable clamps to prevent the cable covering from getting damaged, which makes the machinery or equipment non-compliant with the EMC standards. Removing a ferrite core from the input lines in wiring does not affect inverter running.

 For details about wiring, refer to Chapter 8, Section 8.3 "Compliance with EMC Standards."

### Control circuit terminals

Table 2.5 Names, Symbols and Functions of the Control Circuit Terminals

Classification	Name	Symbol	Functions
Analog input	Power supply for the potentiometer	[13]	Power supply for an external frequency command potentiometer (Variable resistor: 1 to 5k $\Omega$ )
	Analog setting voltage input	[12]	External voltage input that commands the frequency externally.
	Analog setting current input	[C1]	External current input that commands the frequency externally.
	PTC thermistor input		Connection of a PTC (Positive Temperature Coefficient) thermistor for motor protection.
	Analog setting voltage input	[V2]	External voltage input that commands the frequency externally.
	Analog common	[11]	Common terminal for analog input signals.

Table 2.5 Names, Symbols and Functions of the Control Circuit Terminals (Continued)

Classification	Name	Symbol	Functions
Digital input	Digital input 1 to Digital input 7	[X1] to [X7]	(1) Various signals such as "Coast to a stop," "Enable external alarm trip," and "Select multi-frequency" can be assigned to terminals [X1] to [X7], [FWD] and [REV] by setting function codes E01 to E07, E98, and E99. (2) Input mode, i.e. SINK/SOURCE, is changeable by using the slide switch SW1. (3) The logic value (1/0) for ON/OFF of the terminals [X1] to [X7], [FWD], or [REV] can be switched. If the logic value for ON of the terminal [X1] is "1" in the normal logic system, for example, OFF is "1" in the negative logic system and vice versa.
	Run forward command	[FWD]	Short-circuiting terminals [FWD] and [PLC] runs the motor in the forward direction and opening them decelerates the motor to a stop.
	Run reverse command	[REV]	Short-circuiting terminals [REV] and [PLC] runs the motor in the reverse direction and opening them decelerates the motor to a stop.
	Enable input 1 Enable input 2	[EN1] [EN2]	(1) Opening the circuit between terminals [EN1] and [PLC] or terminals [EN2] and [PLC] stops the operation of the inverter output transistor. (2) The input mode of terminals [EN1] and [EN2] is fixed at the SOURCE mode. No switching to the SINK mode is possible. (3) If either one of [EN1] and [EN2] is OFF, an alarm occurs.
	PLC signal power	[PLC]	Connects to PLC output signal power supply.
	Digital input common	[CM]	Common terminals for digital input signals
Analog output	Analog monitor	[FM1] [FM2]	These terminals output monitor signals for analog DC voltage (0 to +10 V) or analog DC current (4 to 20 mA/0 to 20 mA).
	Analog common	[11]	Common terminal for analog output signals.
Transistor output	Transistor output 1 to Transistor output 4	[Y1] to [Y4]	Both the SINK and SOURCE modes are supported. (1) Various signals such as "Inverter running," "Frequency arrival signal," and "Motor overload early warning" can be assigned to terminals [Y1] to [Y4] by setting function code E20 to E23. (2) The logic value (1/0) for ON/OFF of the terminals between one of [Y1] to [Y4] and [CMY] can be switched. If the logic value for ON between one of [Y1] to [Y4] and [CMY] is "1" in the normal logic system, for example, OFF is "1" in the negative logic system and vice versa.
	Transistor output common	[CMY]	Common terminal for transistor output signals
Relay output	General-purpose relay output	[Y5A/C]	(1) Any one of output signals that can be assigned to terminals [Y1] to [Y4] can also be assigned to this relay contact. (2) Whether excitation or non-excitation causes this terminal to output an alarm can be switched.
	Alarm relay output (for any error)	[30A/B/C]	(1) When the protective function is activated, this terminal outputs a contact signal (1C) to stop the motor. (2) Any one of output signals that can be assigned to terminals [Y1] to [Y4] can also be assigned to this relay contact as a multipurpose relay output, to use it for signal output. (3) Whether excitation or non-excitation causes this terminal to output an alarm can be switched.
Communication	RS-485 communications port 2 (On the terminal block)	[DX+]/ [DX-]/ [SD]	These I/O terminals are used as a communications port that transmits data through the RS-485 multipoint protocol between the inverter and a computer or other equipment such as a PLC.
	RS-485 communications port 1 (For connection of the keypad)	RJ-45 connector	Used to connect the keypad to the inverter. The inverter supplies the power to the keypad via the extension cable for remote operation.
	USB port (On the control printed circuit board)	CN10	Used as a USB port connector (mini B) that connects the inverter to a computer. This connector enables connection with the inverter support loader.
Battery	Battery connection	CN11	Connector for an optional battery.

## 2.2.5 Connection diagrams

This section shows connection diagrams with the Enable input function used.

### SINK mode input by factory default

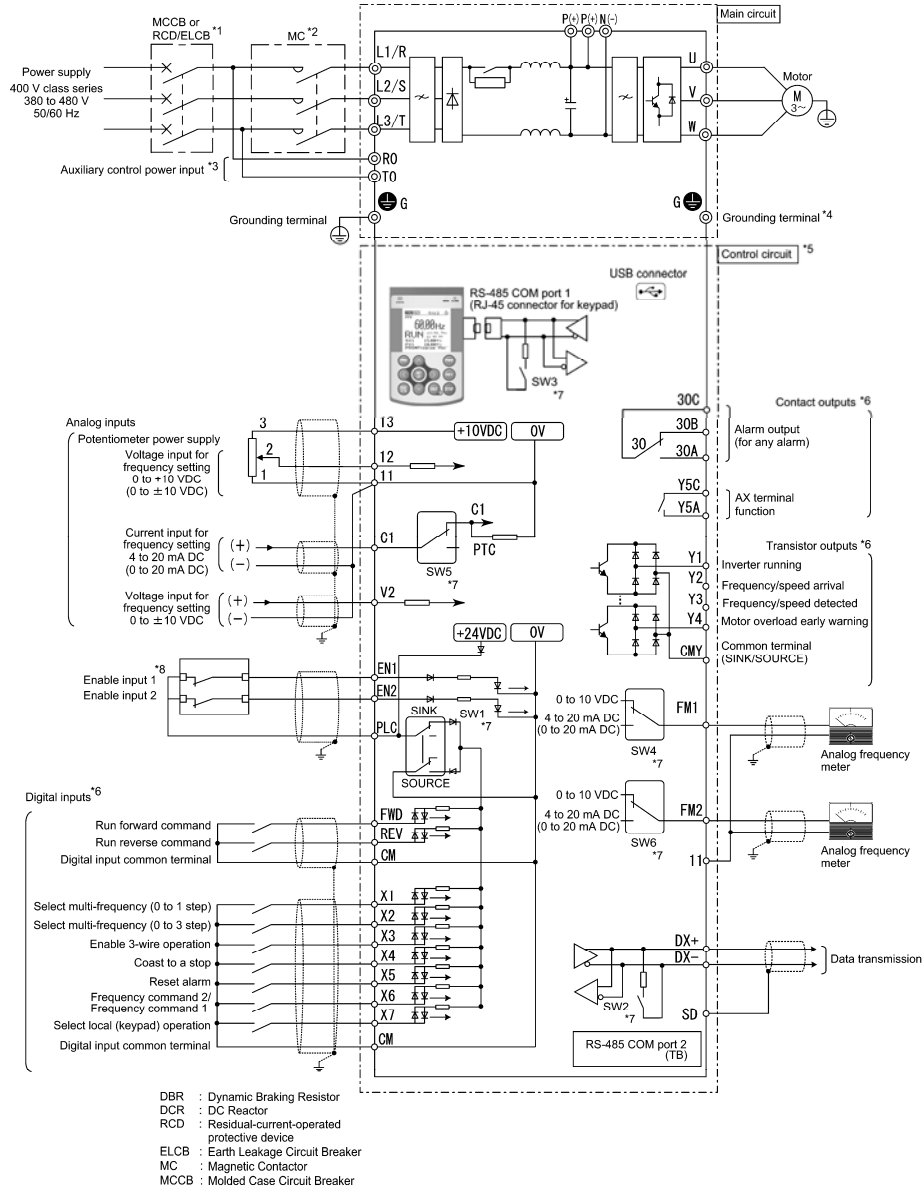

**SOURCE mode input by factory default**

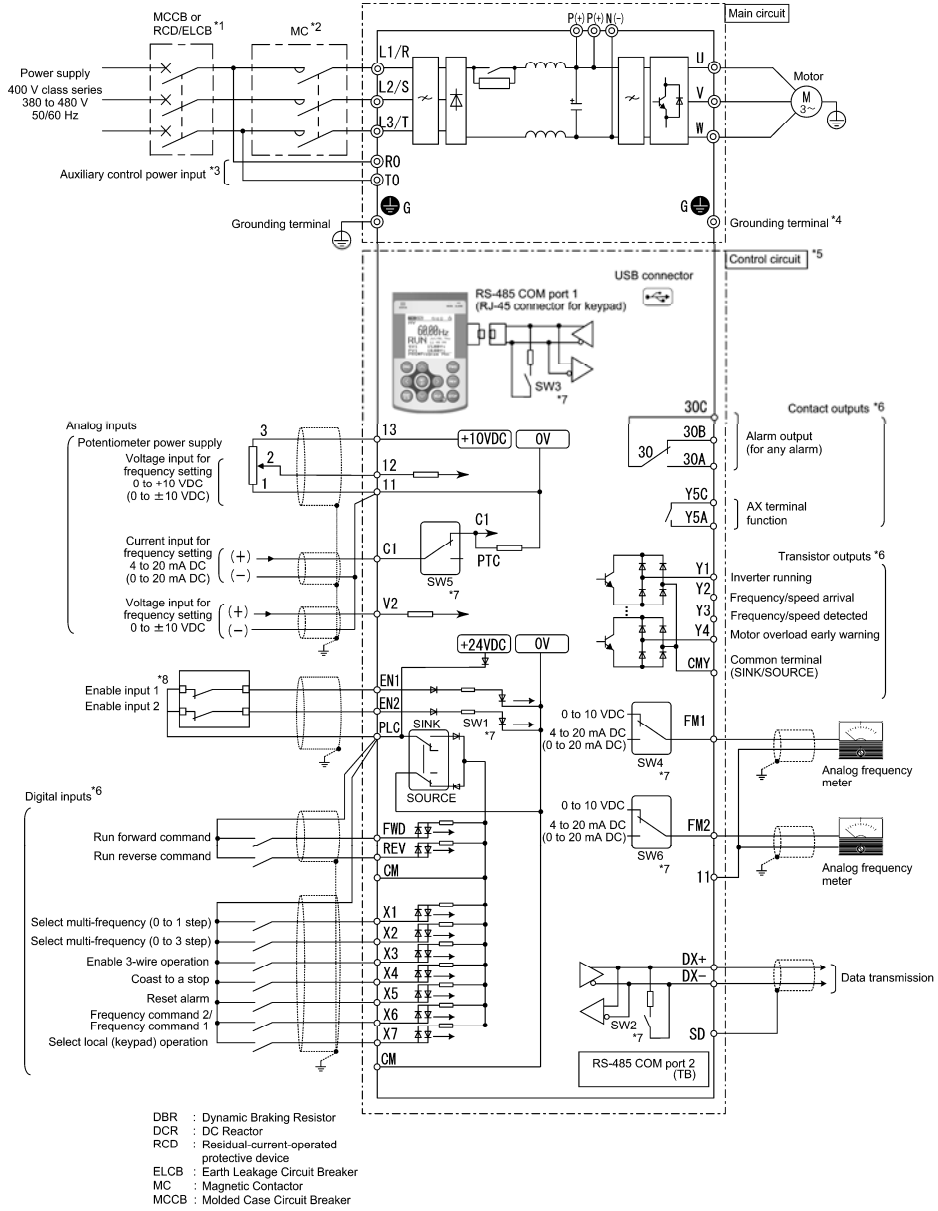

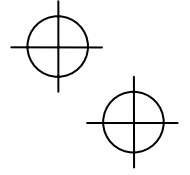
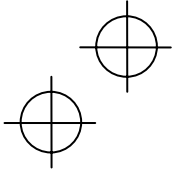

- \*1 Install a recommended molded case circuit breaker (MCCB) or residual-current-operated protective device (RCD)/earth leakage circuit breaker (ELCB) (with overcurrent protection function) in the primary circuit of the inverter to protect wiring. Ensure that the circuit breaker capacity is equivalent to or lower than the recommended capacity.
- \*2 Install a magnetic contactor (MC) for each inverter to separate the inverter from the power supply, apart from the MCCB or RCD/ELCB, when necessary.  
Connect a surge absorber in parallel when installing a coil such as the MC or solenoid near the inverter.
- \*3 To retain an alarm output signal **ALM** issued on inverter's programmable output terminals by the protective function or to keep the keypad alive even if the main power has shut down, connect these terminals to the power supply lines. Even without power supply to these terminals, the inverter can run.  
When these terminals are connected to the power supply lines, shutting down the MC being used for main power ON/OFF cannot power off all live parts. Be sure to shut down all circuits with a disconnecting switch (DS).
- \*4 A grounding terminal for a motor. Use this terminal if needed.
- \*5 For control signal wires, use twisted or shielded-twisted wires. When using shielded-twisted wires, connect the shield of them to the common terminals of the control circuit. To prevent malfunction due to noise, keep the control circuit wiring away from the main circuit wiring as far as possible (recommended: 10 cm or more). Never install them in the same wire duct. When crossing the control circuit wiring with the main circuit wiring, set them at right angles.
- \*6 The connection diagram shows factory default functions assigned to digital input terminals [X1] to [X7], [FWD] and [REV], transistor output terminals [Y1] to [Y4], and relay contact output terminals [Y5A/C] and [30A/B/C].
- \*7 Slide switches on the control printed circuit board (control PCB). Use these switches to customize the inverter operations. For details, refer to Section 2.2.6 "Setting up the slide switches."
- \*8 When the Enable function is not to be used, short-circuit terminals [EN1] and [PLC] and terminals [EN2] and [PLC] using jumper wires. For opening and closing the hardware circuit between terminals [EN1] and [PLC] and between [EN2] and [PLC], use safety components such as safety relays and safety switches. Be sure to use shielded wires exclusive to terminals [EN1] and [PLC] and terminals [EN2] and [PLC]. (Do not put them together with any other control signal wire in the same shielded core.)

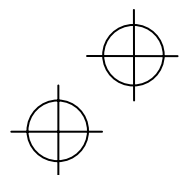
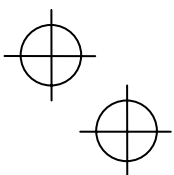



## 2.2.6 Setting up the slide switches

Switching the slide switches located on the control PCB (see Figure 2.4) allows you to customize the operation mode of the analog output terminals, digital I/O terminals, and communications ports.

To access the slide switches, remove the front cover so that you can see the control PCB.

 For details on how to remove the front cover, refer to Section 2.2.1.

Table 2.6 lists function of each slide switch.

Table 2.6 Function of Slide Switches

Switch	Function
SW1	Switches the service mode of the digital input terminals between SINK and SOURCE.
SW2	Switches the terminating resistor of RS-485 communications port on the inverter ON and OFF. (RS-485 communications port 2 on the terminal block)
SW3	Switches the terminating resistor of RS-485 communications port on the inverter ON and OFF. (RS-485 communications port 1 for connecting the keypad)
SW4	Switches the function of terminal [FM1] between VO1 and IO1.
SW5	Switches the function of terminal [C1] between C1 and PTC.
SW6	Switches the function of terminal [FM2] between VO2 and IO2.

Figure 2.4 shows the location of slide switches on the control PCB.

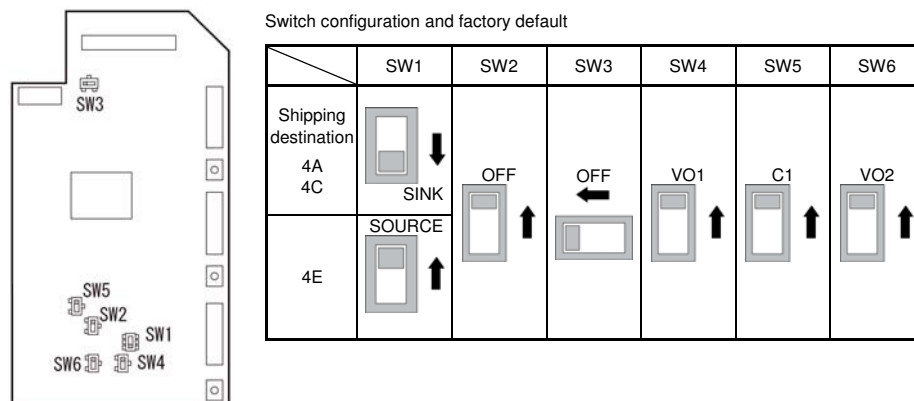

Figure 2.4 Location of the Slide Switches on the Control PCB

**Note** To move a switch slider, use a tool with a narrow tip (e.g., a tip of tweezers). Be careful not to touch other electronic parts, etc. If the slider is in an ambiguous position, the circuit is unclear whether it is turned ON or OFF and the digital input remains in an undefined state. Be sure to place the slider so that it contacts either side of the switch.

## Chapter 3 NAMES AND FUNCTIONS OF KEYPAD COMPONENTS

### 1 LED Indicators

These indicators show the current running status of the inverter.

- STATUS (green): Running state
- WARN. (yellow): Light alarm state
- ALARM (red): Alarm (heavy alarm) state

### 2 LCD Monitor

This monitor shows the following various information about the inverter according to the operation modes.

- Running status and run command source (e.g., Run/stop and rotation direction)
- Status icons (e.g., timer operation, PID operation, battery state, and password protection state)
- Operation guides for the current screen

### 3 Programming Keys

These keys are used to:

- Switch the operation modes between Running mode/Alarm mode and Programming mode.
- Reset the alarm states, discard the setting being configured, and cancel the screen transition according to the operation modes.
- Move the cursor to the digit of data to be modified, shift the setting item, and switch the screen.
- Call up the HELP screen for the current display state.

### 4 Operation Keys

These keys are used to:

- Start running the motor (in the forward/reverse direction).
- Stop the motor.



## Chapter 4 RUNNING THE MOTOR FOR A TEST

### 4.1 Checking Prior to Powering ON

Check the following before powering on the inverter.

- (1) Check that the wiring is correct.  
Especially check the wiring to the inverter input terminals L1/R, L2/S and L3/T and output terminals U, V, and W. Also check that the grounding wires are connected to the grounding terminals (G) correctly. See Figure 4.1.
- (2) Check the control circuit terminals and main circuit terminals for short circuits or ground faults.
- (3) Check for loose terminals, connectors and screws.
- (4) Check that the motor is separated from mechanical equipment.
- (5) Make sure that all switches of devices connected to the inverter are turned OFF. Powering on the inverter with any of those switches being ON may cause an unexpected motor operation.
- (6) Check that safety measures are taken against runaway of the equipment, e.g., a defense to prevent people from access to the equipment.

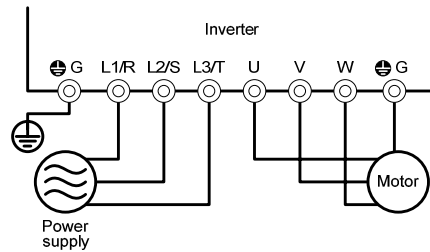

Figure 4.1 Connection of Main Circuit Terminals

### 4.2 Powering ON and Checking

Turn the power ON and check the following points. The following is a case when no function code data is changed from the factory defaults.

- (1) Check that the LCD monitor displays 0.00 Hz (indicating that the reference frequency is 0 Hz) that is blinking. (See Figure 4.2.)  
If the LCD monitor displays any number except 0.00 Hz, press the  $\odot$  /  $\checkmark$  key to set 0.00 Hz.
- (2) Check that the built-in cooling fans rotate.

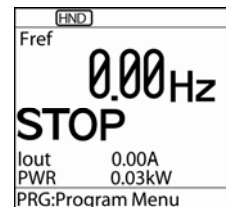

Figure 4.2 Display of the LCD Monitor after Power-ON

**Tip** The reactor in the inverter may generate noise due to source voltage distortion, which is not abnormal.

### 4.3 Configuring the Function Code Data Before Test Run

Configure the function codes listed below according to the motor ratings and your machinery design values. For the motor ratings, check the ratings printed on the motor's nameplate. For your machinery design values, ask system designers about them.

Function code	Name	Function code data	Factory defaults
F04	Base frequency 1	Motor ratings (printed on the nameplate of the motor)	50.0 (Hz)
F05	Rated voltage at base frequency 1		Asia: 415 (V) Europe: 400 (V)
P02	Motor 1 (Rated capacity)		Nominal applied motor capacity
P03	Motor 1 (Rated current)		Rated current of nominal applied motor
P99	Motor 1 selection		0: Motor characteristics 0 (Fuji standard motors, 8-series)
F03	Maximum frequency 1	Machinery design values	50.0 (Hz)
F07	Acceleration time 1 (Note)	(Note) For a test run of the motor, increase values so that they are longer than your machinery design values. If the specified time is short, the inverter may not run the motor properly.	20.00 (s)
F08	Deceleration time 1 (Note)		20.00 (s)

After the above configuration, initialize motor 1 with the function code H03 (data = 2). It automatically updates the necessary motor parameters P01, P03, P06 to P08, P10, P12, and H46.

 For details about the configuration procedure of function codes, refer to the User's Manual, Chapter 5, Section 5.6.2.1 "Configuring function codes."

### 4.4 Running the Inverter for Motor Operation Check

After completion of preparations for a test run as described above, start running the inverter for motor operation check using the following procedure.

#### ----- Test Run Procedure -----

- (1) Turn the power ON and check that the reference frequency 0.00 Hz is blinking on the LCD monitor.
- (2) Set a low reference frequency such as 5 Hz, using  $\Delta$  /  $\nabla$  keys. (Check that the frequency is blinking on the LCD monitor.)
- (3) Press the  $\text{FWD}$  key to start running the motor in the forward direction. (Check that the reference frequency is blinking on the LCD monitor.)
- (4) To stop the motor, press the  $\text{STOP}$  key.

#### < Check points during a test run >

- Check that the motor is running in the forward direction.
- Check for smooth rotation without motor humming or excessive vibration.
- Check for smooth acceleration and deceleration.

When no abnormality is found, press the  $\text{FWD}$  key again to start driving the motor, then increase the reference frequency using  $\Delta$  /  $\nabla$  keys. Check the above points again.

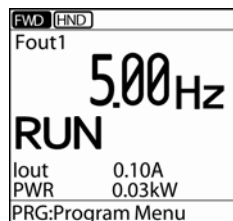

### 4.5 Preparation for Practical Operation

After verifying normal motor running with the inverter in a test run, proceed to the practical operation. For details, refer to the User's Manual.

## Chapter 5 TROUBLESHOOTING

### 5.1 Alarm Codes

Table 5.1 Quick List of Alarm Codes

Code	Name	Description
<i>OC 1</i> <i>OC 2</i> <i>OC 3</i>	Instantaneous overcurrent	The inverter momentary output current exceeded the overcurrent level. <i>OC 1</i> : Overcurrent during acceleration <i>OC 2</i> : Overcurrent during deceleration <i>OC 3</i> : Overcurrent during running at a constant speed
<i>OU 1</i> <i>OU 2</i> <i>OU 3</i>	Overvoltage	The DC link bus voltage exceeded the overvoltage detection level. <i>OU 1</i> : Overvoltage during acceleration <i>OU 2</i> : Overvoltage during deceleration <i>OU 3</i> : Overvoltage during running at a constant speed
<i>LU</i>	Undervoltage	The DC link bus voltage dropped below the undervoltage detection level.
<i>Lin</i>	Input phase loss	An input phase loss occurred or the Interphase voltage unbalance rate was large.
<i>OPL</i>	Output phase loss	An output phase loss occurred.
<i>OH 1</i>	Heat sink overheat	The temperature around the heat sink has risen abnormally.
<i>OH 2</i>	External alarm	The external alarm <b>THR</b> was entered. (when the <b>THR</b> "Enable external alarm trip" has been assigned to any digital input terminal)
<i>OH 3</i>	Inverter internal overheat	The temperature inside the inverter has exceeded the allowable limit.
<i>OH 4</i>	Motor protection (PTC thermistor)	The temperature of the motor has risen abnormally.
<i>OL 1</i>	Overload of motor 1	The electronic thermal protection for motor overload detection was activated.
<i>OLU</i>	Inverter overload	The temperature inside the inverter has risen abnormally.
<i>Er 1</i>	Memory error	An error has occurred in writing data to the memory in the inverter.
<i>Er 2</i>	Keypad communications error	A communications error has occurred between the keypad and the inverter.
<i>Er 3</i>	CPU error	A CPU error or LSI error has occurred.
<i>Er 4</i>	Option communications error	A communications error has occurred between the connected option card and the inverter.
<i>Er 5</i>	Option error	An error was detected by the connected option card (not by the inverter).
<i>Er 6</i>	Operation protection	An incorrect operation was attempted.
<i>Er 7</i>	Tuning error	Auto-tuning has failed, resulting in abnormal tuning results.
<i>Er 8</i> <i>Er P</i>	RS-485 communications error (COM port 1) RS-485 communications error (COM port 2)	A communications error has occurred during RS-485 communication.
<i>Er F</i>	Data saving error during undervoltage	When the undervoltage protection was activated, the inverter failed to save data, showing this error.
<i>Er H</i>	Hardware error	The LSI on the power printed circuit board has malfunctioned due to noise, etc.
<i>Pu 1</i> <i>Pu 2</i> <i>Pu A</i> <i>Pu b</i> <i>Pu c</i>	PID feedback error	The PID feedback signal wire is broken under PID control.
<i>ECF</i>	Enable circuit failure	The Enable circuit was diagnosed as a circuit failure.
<i>ECL</i>	Customizable logic error	A customizable logic configuration error has caused an alarm.
<i>Pdr</i>	Drought protection	A droughty state was detected under PID control.

Code	Name	Description
<i>rOL</i>	Frequently-activated operation protection	The slow flowrate stop function has been frequently activated under PID control.
<i>POL</i>	High flowrate protection	A high flowrate was detected under PID control.
<i>rLO</i>	Stuck prevention	The inverter failed to start due to overcurrent.
<i>FOl</i>	Filter clogging error	An overload state was detected under PID control.
<i>Err</i>	Mock alarm	A mock alarm has been generated intentionally by keypad operation.

## Chapter 6 MAINTENANCE AND INSPECTION

Perform daily and periodic inspections to avoid trouble and keep reliable operation of the inverter for a long time.

### 6.1 Daily Inspection

Visually inspect the inverter for operation errors from the outside without removing the covers when the inverter is ON or operating.

- Check that the expected performance (satisfying the standard specification) is obtained.
- Check that the surrounding environment (temperature, surrounding space, etc.) satisfies the requirements.
- Check that the keypad displays normally.
- Check for abnormal noise, odor, or excessive vibration.
- Check for traces of overheat, discoloration and other defects.

### 6.2 Periodic Inspection

Before starting periodic inspections, be sure to stop the motor, shut down the power, and wait at least 10 minutes. Further, make sure, using a multimeter or a similar instrument, that the DC link bus voltage between the main circuit terminals P(+) and N(-) has dropped to the safe level (+25 VDC or below).

Table 6.1 List of Periodic Inspections

Check part	Check item	How to inspect	Evaluation criteria
Environment	<ol style="list-style-type: none"> <li>1) Check the surrounding temperature, humidity, vibration and atmosphere (dust, gas, oil mist, or water drops).</li> <li>2) Check that tools or other foreign materials or dangerous objects are not left around the equipment.</li> </ol>	<ol style="list-style-type: none"> <li>1) Check visually or measure using apparatus.</li> <li>2) Visual inspection</li> </ol>	<ol style="list-style-type: none"> <li>1) The standard specifications must be satisfied.</li> <li>2) No foreign or dangerous objects are left.</li> </ol>
Input voltage	Check that the input voltages of the main and control circuit are correct.	Measure the input voltages using a multimeter or the like.	The standard specifications must be satisfied.
Keypad	<ol style="list-style-type: none"> <li>1) Check that the display is clear.</li> <li>2) Check that there is no missing part in the displayed characters.</li> </ol>	<ol style="list-style-type: none"> <li>1), 2) Visual inspection</li> </ol>	<ol style="list-style-type: none"> <li>1), 2) The display can be read and there is no fault.</li> </ol>
Structure such as frame and cover	Check for: <ol style="list-style-type: none"> <li>1) Abnormal noise or excessive vibration</li> <li>2) Loose bolts (at clamp sections).</li> <li>3) Deformation and breakage</li> <li>4) Discoloration caused by overheat</li> <li>5) Contamination and accumulation of dust or dirt</li> </ol>	<ol style="list-style-type: none"> <li>1) Visual or auditory inspection</li> <li>2) Retighten.</li> <li>3), 4), 5) Visual inspection</li> </ol>	<ol style="list-style-type: none"> <li>1), 2), 3), 4), 5) No abnormalities</li> </ol>
Main circuit	Common	<ol style="list-style-type: none"> <li>1) Retighten.</li> <li>2), 3) Visual inspection</li> </ol>	<ol style="list-style-type: none"> <li>1), 2), 3) No abnormalities</li> </ol>
	Conductors and wires	<ol style="list-style-type: none"> <li>1), 2) Visual inspection</li> </ol>	<ol style="list-style-type: none"> <li>1), 2) No abnormalities</li> </ol>

Table 6.1 List of Periodic Inspections (Continued)

Check part	Check item	How to inspect	Evaluation criteria	
Main circuit	Terminal blocks	Check that the terminal blocks are not damaged.	Visual inspection	No abnormalities
	DC link bus capacitor	1) Check for electrolyte leakage, discoloration, cracks and swelling of the casing. 2) Check that the safety valve does not protrude remarkably. 3) Measure the capacitance if necessary.	1), 2) Visual inspection  3) Measure the discharge time with capacitance probe.	1), 2) No abnormalities  3) The discharge time should not be shorter than the one specified by the replacement manual.
	Transformer and reactor	Check for abnormal roaring noise and odor.	Auditory, visual, and olfactory inspection	No abnormalities
	Magnetic contactor and relay	1) Check for chatters during operation. 2) Check that contact surface is not rough.	1) Auditory inspection 2) Visual inspection	1), 2) No abnormalities
Control circuit	Printed circuit board	1) Check for loose screws and connectors. 2) Check for odor and discoloration. 3) Check for cracks, breakage, deformation and remarkable rust. 4) Check the capacitors for electrolyte leaks and deformation.	1) Retighten. 2) Olfactory and visual inspection 3), 4) Visual inspection	1), 2), 3), 4) No abnormalities
Cooling system	Cooling fan	1) Check for abnormal noise and excessive vibration.  2) Check for loose bolts. 3) Check for discoloration caused by overheat.	1) Auditory and visual inspection, or turn manually (be sure to turn the power OFF). 2) Retighten. 3) Visual inspection	1) Smooth rotation  2), 3) No abnormalities
	Ventilation path	Check the heat sink, intake and exhaust ports for clogging and foreign materials.	Visual inspection	No abnormalities

Remove dust accumulating on the inverter with a vacuum cleaner. If the inverter is stained, wipe it off with a chemically neutral cloth.



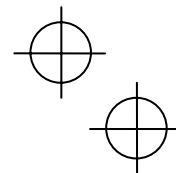
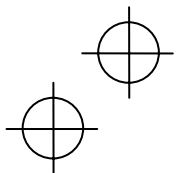

### 6.3 List of Periodic Replacement Parts

Each part of the inverter has its own service life that will vary according to the environmental and operating conditions. It is necessary to replace the following parts at the intervals specified below as a guide.

When the replacement is necessary, consult your Fuji Electric representative.

Table 6.2 Replacement Parts

Part name	Standard replacement intervals (See Notes below.)
DC link bus capacitor	5 years
Electrolytic capacitors on printed circuit boards	5 years
Cooling fans	5 years

(Notes) These replacement intervals are based on the inverter's service life estimated at a surrounding temperature of 30°C (IP55) or 40°C (IP21) at full load (100% of the inverter rated current). In environments with a surrounding temperature higher than that or a large amount of dust or dirt, the replacement intervals may be shorter.

Standard replacement intervals mentioned above are only a guide for replacement, not a guaranteed service life.

### 6.4 Inquiries about Product and Guarantee

#### 6.4.1 When making an inquiry

Upon breakage of the product, uncertainties, failure or inquiries, inform your Fuji Electric representative of the following information.

- 1) Inverter type (Refer to Chapter 1, Section 1.1.)
- 2) SER No. (serial number of the product) (Refer to Chapter 1, Section 1.1.)
- 3) Function codes and their data that you changed (Refer to the User's Manual, Chapter 5, Section 5.6.3.2.)
- 4) ROM version (Refer to User's Manual, Chapter 5, Section 5.6.4.4.)
- 5) Date of purchase
- 6) Inquiries (for example, point and extent of breakage, uncertainties, failure phenomena and other circumstances)

#### 6.4.2 Product warranty

The product warranty period is "1 year from the date of purchase" or "24 months from the manufacturing date printed on the nameplate," whichever date is earlier.

However, if the following cases are applicable, the terms of this warranty may not apply.

- 1) The breakdown was caused by inappropriate usage, repairs, or modifications.
- 2) The product was used exceeding the standard specification range.
- 3) The breakdown was caused by drops after purchase, or damages or breaks caused during transportation.
- 4) The breakdown was caused by a reason such as earthquake, fire, storm and flood, lightning, abnormal power voltage and other disasters, and the secondary damages.

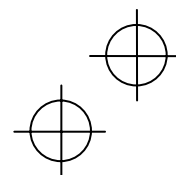
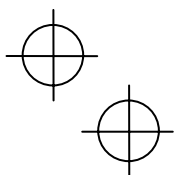

## Chapter 7 SPECIFICATIONS

### 7.1 Standard Model

Three-phase 400 V class series

Item		Specifications												
Type (FRN_ _ _AQ1 ■-4□)	*1	0.75	1.5	2.2	3.7 (4.0)*4	5.5	7.5	11	15	18.5	22	30	37	
Nominal applied motor (kW)	*2	0.75	1.5	2.2	3.7 (4.0)*4	5.5	7.5	11	15	18.5	22	30	37	
Output ratings	Rated capacity (kVA)	1.9	3.1	4.1	6.8	10	14	18	24	29	34	45	57	
	Rated current (A)	2.5	4.1	5.5	9.0	13.5	18.5	24.5	32	39	45	60	75	
Input power	Rated current (A) *3	1.6	3.0	4.3	7.4	10.3	13.9	20.7	27.9	34.5	41.1	55.7	69.4	
	Required capacity (kVA)	1.2	2.1	3.0	5.2	7.2	9.7	15	20	24	29	39	49	
EMC filter (IEC/EN 61800-3: 2004)		Compliant with EMC Directives, Emission and Immunity: Category C2 (2nd Env.)												
DC reactor (DCR)		Available as standard (IEC/EN 61000-3-2, IEC/EN 61000-3-12)												
Power factor (at the rated load)	Fundamental wave power factor	> 0.98												
	Total power factor	≥ 0.90												
Efficiency (at the rated load)		95%	96%	96%	96%	97%	96%	97%	97%	97%	97%	97%	97%	
Cooling method		Fan cooling												
Weight / Mass (kg)	IP21	10	10	10	10	10	10	18	18	18	18	23	23	
	IP55	10	10	10	10	10	10	18	18	18	18	23	23	
Environmental Requirements	Site location	Indoors												
	Surrounding temperature	IP00/IP21	-10 to +50°C (-10 to +40°C when inverters of 37 kW or below are mounted side-by-side without any clearance between them.)											
		IP55	-10 to +40°C (-10 to +30°C when inverters of 37 kW or below are mounted side-by-side without any clearance between them.)											
	Relative humidity	5 to 95% (No condensation)												
	Atmosphere	The inverter must not be exposed to dust, direct sunlight, corrosive gases, flammable gases, oil mist, vapor or water drops. Pollution degree 2 (IEC60664-1) *5 The atmosphere can contain a small amount of salt. (0.01 mg/cm <sup>2</sup> or less per year) The inverter must not be subjected to sudden changes in temperature that will cause condensation to form.												
	Altitude	1,000 m max. *6												
	Atmospheric pressure	86 to 106 kPa												
Vibration	3 mm            2 to less than 9 Hz 10 m/s <sup>2</sup> 9 to less than 200 Hz													

\*1 A box (■) replaces an alphabetic letter depending on the enclosure. A box (□) replaces an alphabetic letter depending on the shipping destination.

\*2 Fuji 4-pole standard motor

\*3 When the inverter is connected to the power supply of 400 V, 50 Hz, R<sub>sce</sub> = 120.

\*4 4.0 kW for the EU.

\*5 Do not install the inverter in an environment where it may be exposed to lint, cotton waste or moist dust or dirt which will clog the heat sink of the inverter. If the inverter is to be used in such an environment, install it in a dustproof panel of your system.

\*6 If you use the inverter in an altitude above 1000 m, you should apply an output current derating factor as listed in the table below.

Altitude	1000 m or lower	1000 to 1500 m	1500 to 2000 m	2000 to 2500 m	2500 to 3000 m
Output current derating factor	1.00	0.97	0.95	0.91	0.88

## 7.2 External Dimensions

Rated voltage	Inverter type	Dimensions (mm)							
		Figure A			Figure B				
		W	H	D	W1	H1	H2	φA	W2
Three-phase 400V	FRN0.75AQ1■-4□	150	465	262	115	451	7	8	8
	FRN1.5AQ1■-4□								
	FRN2.2AQ1■-4□								
	FRN3.7AQ1■-4□								
	FRN4.0AQ1■-4E*								
	FRN5.5AQ1■-4□								
	FRN7.5AQ1■-4□	203	585	262	158	571			
	FRN11AQ1■-4□								
	FRN15AQ1■-4□								
	FRN18.5AQ1■-4□								
	FRN22AQ1■-4□								
FRN30AQ1■-4□	645				631				
FRN37AQ1■-4□									

\* 4.0 kW for the EU. The inverter type is FRN4.0AQ1■-4E.

**Note** A box (■) replaces an alphabetic letter depending on the enclosure.

A box (□) replaces an alphabetic letter depending on the shipping destination.

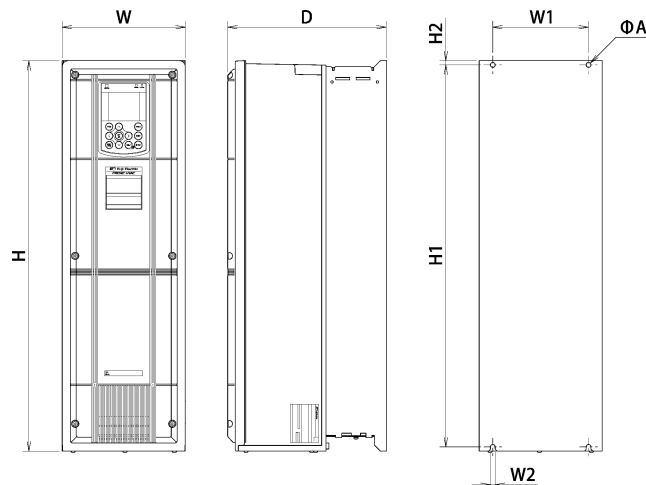

Figure A

Figure B

External Dimensions of the Inverter (Typical)

## Chapter 8 CONFORMITY WITH STANDARDS

### 8.1 Compliance with European Standards

The CE marking on Fuji products indicates that they comply with the essential requirements of the Electromagnetic Compatibility (EMC) Directive 2004/108/EC and Low Voltage Directive 2006/95/EC which are issued by the Council of the European Communities.

#### The products comply with the following standards

Low Voltage Directive	EN61800-5-1: 2007
EMC Directives	EN61800-3 : 2004 Immunity : Second environment (Industrial) Emission : Category C2

### 8.2 Conformity to the Lower Voltage Directive in the EU

To use Fuji inverters as a product conforming to the Lower Voltage Directive in the EU, refer to guidelines given on pages vi and vii.

### 8.3 Compliance with EMC Standards

#### 8.3.1 General

The CE marking on inverters does not ensure that the entire equipment including our CE-marked products is compliant with the EMC Directive. Therefore, CE marking for the equipment shall be the responsibility of the equipment manufacturer. For this reason, Fuji's CE mark is indicated under the condition that the product shall be used within equipment meeting all requirements for the relevant Directives. Instrumentation of such equipment shall be the responsibility of the equipment manufacturer.

Generally, machinery or equipment includes not only our products but other devices as well. Manufacturers, therefore, shall design the whole system to be compliant with the relevant Directives.



Our EMC compliance test is performed under the following conditions.

Wiring length (of the shielded cable) between the inverter and motor: 75 m

For detailed restrictions by the wiring length and carrier frequency setting, refer to the User's Manual.

#### 8.3.2 Recommended installation procedure

To make the machinery or equipment fully compliant with the EMC Directive, have certified technicians wire the motor and inverter in strict accordance with the procedure given below.

- 1) Use shielded wires for the motor cable and route the cable as short as possible. Firmly clamp the shield to the specified point or the grounded metal plate inside the inverter. Further, connect the shielding layer electrically to the grounding terminal of the motor.
- 2) For the inverters of 11 to 37 kW, be sure to pass the main circuit power input lines of the inverter through a ferrite core in wiring.
- 3) Connect the grounding wires to the grounding terminals without passing them through a ferrite core.

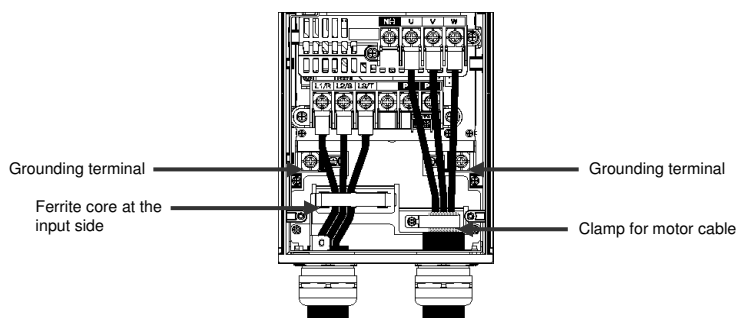

Figure 8.1 Wiring to Main Circuit Terminals for Inverters of 30/37 kW

**Tip** Inverters of 11 to 37 kW: When shielded wires are not used for the motor cable, remove the motor cable clamps to prevent the cable covering from getting damaged, which makes the machinery or equipment incompliant with the EMC standards. Removing a ferrite core from the input lines in wiring does not affect inverter running.

- 4) For connection to inverter's control terminals and for connection of the RS-485 communication signal cable, use shielded wires. As with the motor, clamp the shields firmly to the specified point or the grounded metal plate inside the inverter.

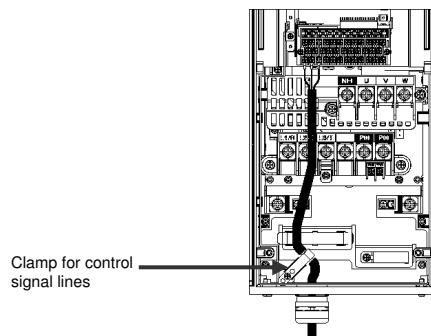

Figure 8.2 Wiring to Control Circuit Terminals for Inverters of 30/37 kW

### 8.3.3 Leakage current of the EMC filter

This product uses grounding capacitors for noise suppression which increase the leakage current. Check whether there is no problem with electrical systems.

Table 8.1 Leakage Current of EMC Filter

Input power	Inverter type	Leakage current (mA)	Input power	Inverter type	Leakage current (mA)
Three-phase 400 V	FRN0.75AQ1■-4□	37	Three-phase 400 V	FRN11AQ1■-4□	95
	FRN1.5AQ1■-4□			FRN15AQ1■-4□	
	FRN2.2AQ1■-4□			FRN18.5AQ1■-4□	
	FRN3.7AQ1■-4□			FRN22AQ1■-4□	
	FRN4.0AQ1■-4□			FRN30AQ1■-4□	
	FRN5.5AQ1■-4□			FRN37AQ1■-4□	
	FRN7.5AQ1■-4□		78		

\* Calculated based on these measuring conditions: 400 V, 50 Hz, neutral grounding in Y-connection, interphase voltage unbalance ratio 2%.

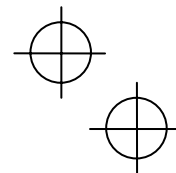
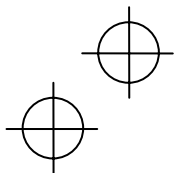

## 8.4 Harmonic Component Regulation in the EU

### 8.4.1 General comments

When general-purpose industrial inverters are used in the EU, the harmonics emitted from inverters to the power lines are strictly regulated as stated below.

If an inverter whose rated input is 1 kW or less is connected to the public low-voltage power supply, it is regulated by the harmonics emission regulation EN/IEC61000-3-2. If an inverter whose input current is 16 A or above and 75 A or below is connected to the public low-voltage power supply, it is regulated by the harmonics emission regulation EN61000-3-12.

Note that connection to the industrial low-voltage power lines is an exception. (See Figure 8.3.)

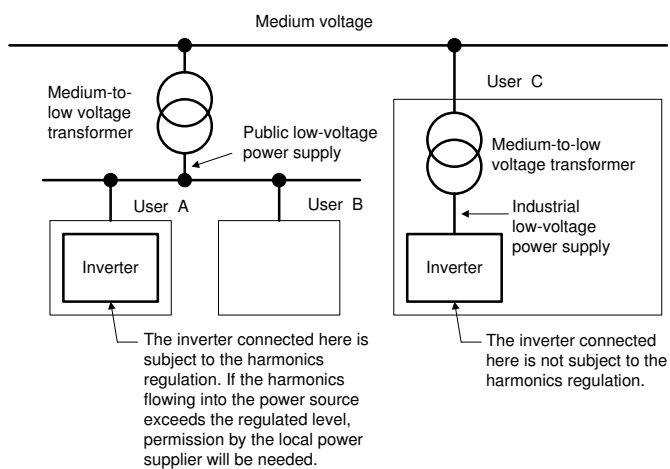

Figure 8.3 Power Source and Regulation

### 8.4.2 Compliance with EN61000-3-2

The FRN0.75AQ1■-4□ satisfies the EN61000-3-2.

### 8.4.3 Compliance with EN61000-3-12

To bring the FRN0.75AQ1■-4□ to FRN37AQ1■-4□ into compliance with the EN61000-3-12, connect them to the public low-voltage power supply whose short-circuit ratio  $R_{sc}$  is 120 or above.

## 8.5 Compliance with UL Standards and Canadian Standards (cUL certification)

### 8.5.1 General

Originally, the UL standards were established by Underwriters Laboratories, Inc. as private criteria for inspections/investigations pertaining to fire/accident insurance in the USA. The UL marking on Fuji products is related to the UL Standard UL508C.

cUL certification means that UL has given certification for products to clear CSA Standards. cUL certified products are equivalent to those compliant with CSA Standards. The cUL marking on Fuji products is related to the CSA Standard C22.2 No. 14.

### 8.5.2 Considerations when using FRENIC-HVAC in systems to be certified by UL and cUL

If you want to use the FRENIC-HVAC series of inverters as a part of UL Standards or CSA Standards (cUL certified) certified product, refer to the related guidelines described on pages viii to x.

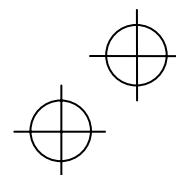
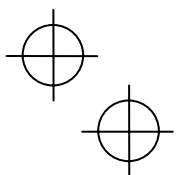

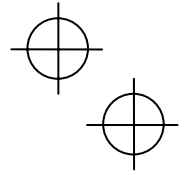
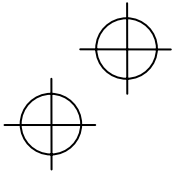

# ***FRENIC-AQUA***

---

## **Instruction Manual**

First Edition, November 2011

Fuji Electric Co., Ltd.

---

The purpose of this instruction manual is to provide accurate information in handling, setting up and operating of the FRENIC-AQUA series of inverters. Please feel free to send your comments regarding any errors or omissions you may have found, or any suggestions you may have for generally improving the manual.

In no event will Fuji Electric Co., Ltd. be liable for any direct or indirect damages resulting from the application of the information in this manual.

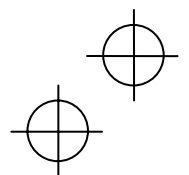
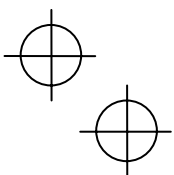

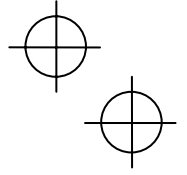
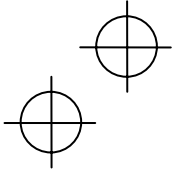

## **Fuji Electric Co., Ltd.**

Gate City Ohsaki, East Tower, 11-2, Osaki 1-chome, Shinagawa-ku, Tokyo 141-0032, Japan

Phone: +81 3 5435 7058 Fax: +81 3 5435 7420

URL <http://www.fujielectric.com/>

